

SKa 3

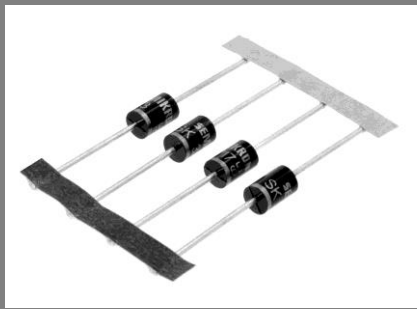

Axial Lead Diode

Avalanche Diode

SKa 3

Features

- Avalanche type reverse characteristic
- Transient voltage proof within specified limits
- Taped for automatic insertion
- Available with formed leads on request
- Plastic material meets UL 94V-0 flammability classification

Typical Applications

- DC supply for magnets or solenoids (brakes, valves, etc.)
- Series connections for high voltage applications (dust precipitators)

$V_{(BR)min}$ V	$I_{FRMS} = 6,7$ A (maximum value for continuous operation) $I_{FAV} = 3$ A (sin. 180; $T_r = 90^\circ\text{C}$)	C_{max} μF	R_{min} Ω
1300	SKa 3/13	1600	2
1700	SKa 3/17	800	4
2000	SKa 3/20	500	6

Symbol	Condition	Values	Units
I_{FAV}	$T_r = 85^\circ\text{C}$; $L = 10$ mm; sin. 180 $T_a = 45^\circ\text{C}$; PCB 50 x 50 mm	3,3	A
		1,8	A
I_{FSM}	$T_{vj} = 25^\circ\text{C}$; 10 ms $T_{vj} = 150^\circ\text{C}$; 10 ms	180	A
		150	A
i^2t	$T_{vj} = 25^\circ\text{C}$; 8,3...10 ms $T_{vj} = 150^\circ\text{C}$; 8,3...10 ms	162	A^2s
		112,5	A^2s
V_F	$T_{vj} = 25^\circ\text{C}$, $I_F = 10$ A	max. 1,2	V
$V_{(TO)}$	$T_{vj} = 150^\circ\text{C}$	max. 0,85	V
r_T	$T_{vj} = 150^\circ\text{C}$	max. 30	$\text{m}\Omega$
I_R	$T_{vj} = 150^\circ\text{C}$; $V_{RD} = V_{(BR)min}$	max. 600	μA
P_{RSM}	$T_{vj} = 150^\circ\text{C}$; $t_p = 10$ μs	1,8	kW
$R_{th(i-r)}$	$L = 10$ mm	18	K/W
$R_{th(i-a)}$	PCB 50 x 50 mm	60	K/W
T_{vj}		-40...+150	$^\circ\text{C}$
T_{stg}		-40...+150	$^\circ\text{C}$
T_{SOLD}	max. 10 s; $L > 9$ mm	250	$^\circ\text{C}$
a		5 * 9,81	m/s^2
m	approx.	1	g
Case	1500 diodes per reel	E34	

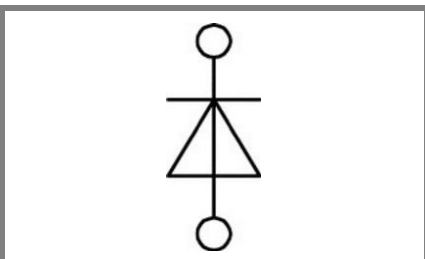

SK

SKa 3

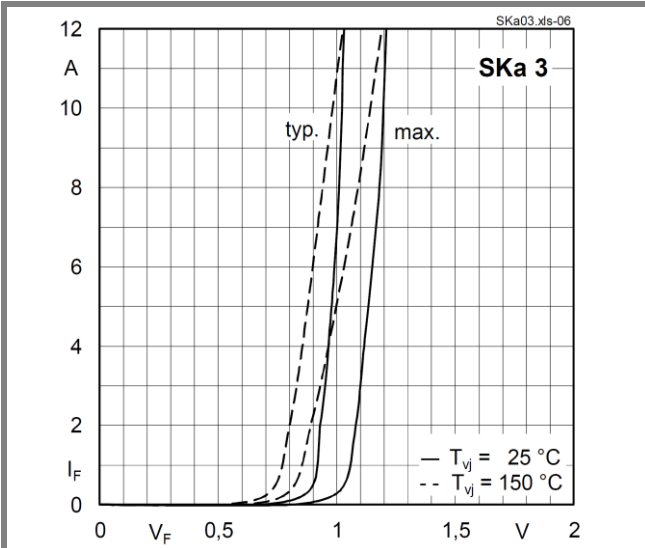

Fig. 6 Forward characteristics

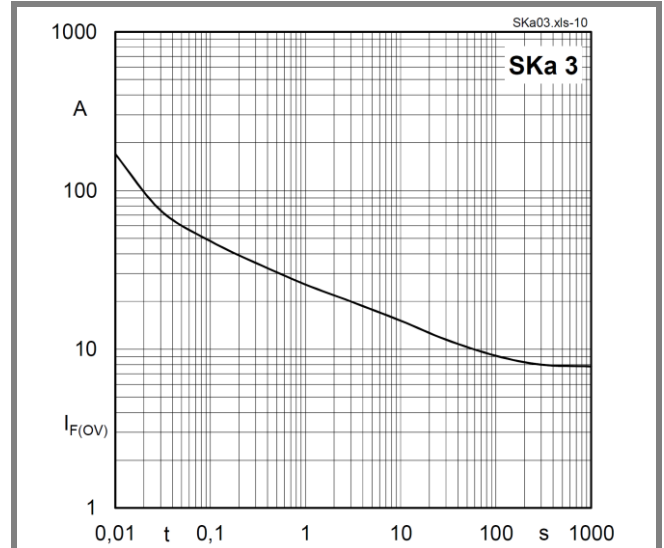

Fig. 10 Overload current vs. time

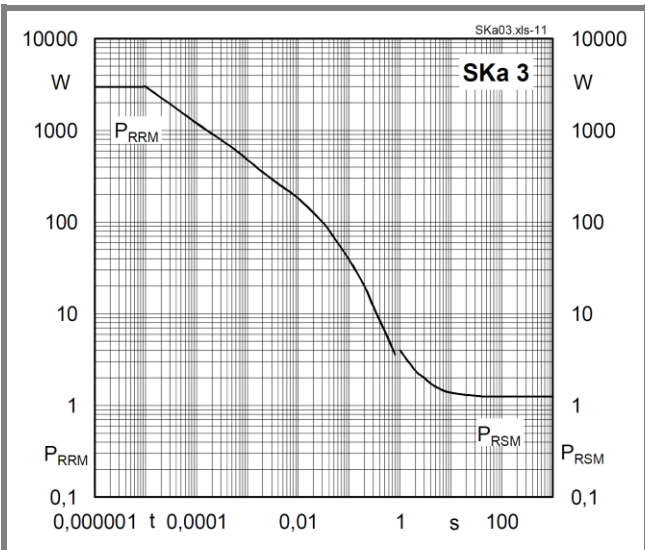

Fig. 11 Reverse power dissipation vs. time

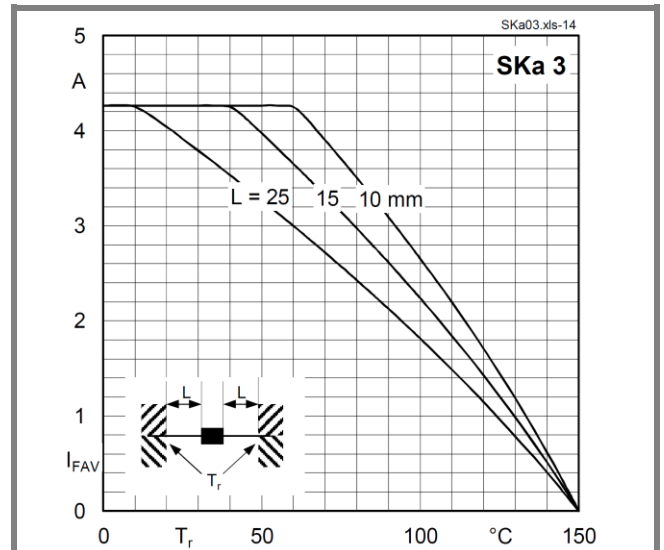

Fig. 14 Forward current vs. reference temperature

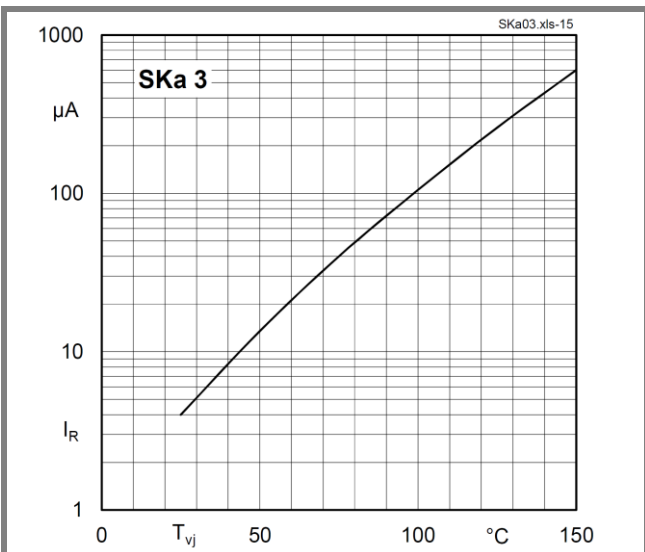

Fig. 15 Reverse current vs. junction temperature

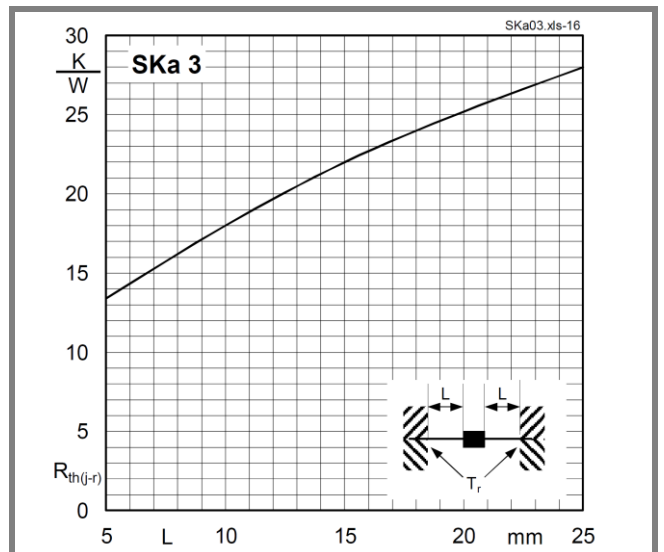
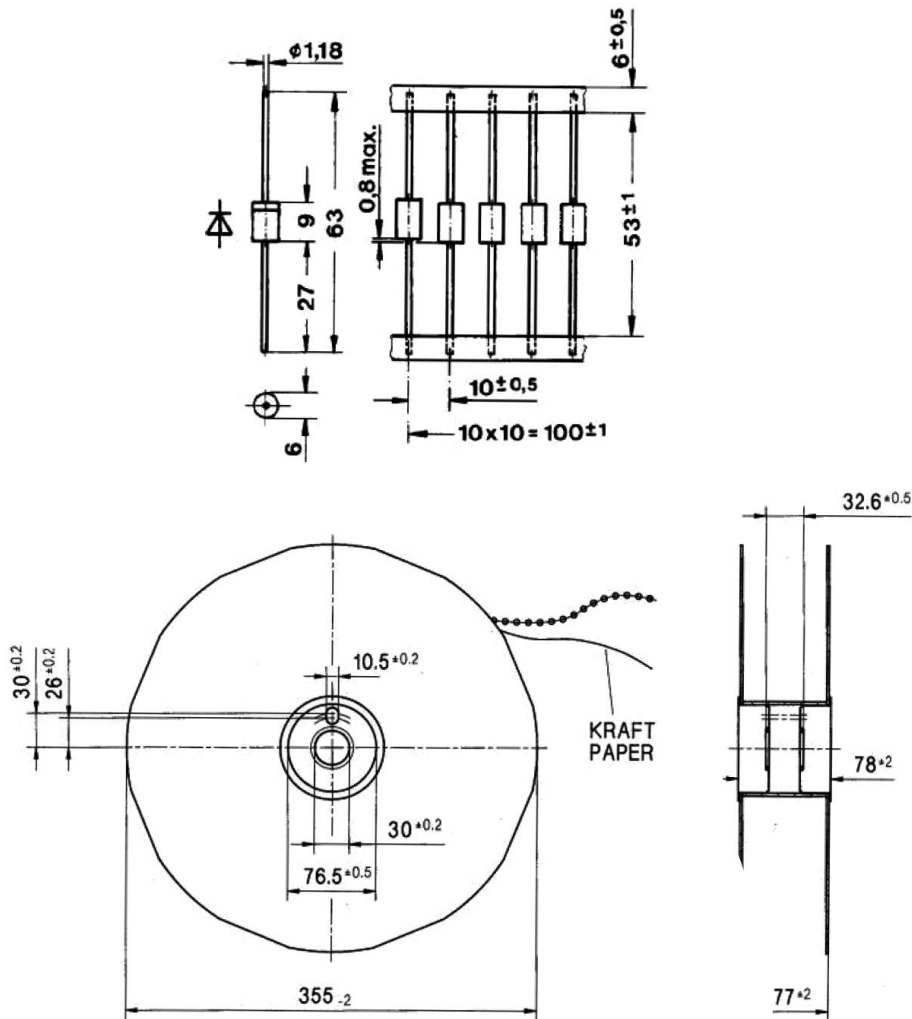

Fig. 16 Thermal resistance vs. lead length



Case E34

*IMPORTANT INFORMATION AND WARNINGS

The specifications of SEMIKRON products may not be considered as guarantee or assurance of product characteristics ("Beschaffheitsgarantie"). The specifications of SEMIKRON products describe only the usual characteristics of products to be expected in typical applications, which may still vary depending on the specific application. Therefore, products must be tested for the respective application in advance. Application adjustments may be necessary. The user of SEMIKRON products is responsible for the safety of their applications embedding SEMIKRON products and must take adequate safety measures to prevent the applications from causing a physical injury, fire or other problem if any of SEMIKRON products become faulty. The user is responsible to make sure that the application design is compliant with all applicable laws, regulations, norms and standards. Except as otherwise explicitly approved by SEMIKRON in a written document signed by authorized representatives of SEMIKRON, SEMIKRON products may not be used in any applications where a failure of the product or any consequences of the use thereof can reasonably be expected to result in personal injury. No representation or warranty is given and no liability is assumed with respect to the accuracy, completeness and/or use of any information herein, including without limitation, warranties of non-infringement of intellectual property rights of any third party. SEMIKRON does not assume any liability arising out of the applications or use of any product; neither does it convey any license under its patent rights, copyrights, trade secrets or other intellectual property rights, nor the rights of others. SEMIKRON makes no representation or warranty of non-infringement or alleged noninfringement of intellectual property rights of any third party which may arise from applications. Due to technical requirements our products may contain dangerous substances. For information on the types in question please contact the nearest SEMIKRON sales office. This document supersedes and replaces all information previously supplied and may be superseded by updates. SEMIKRON reserves the right to make changes.