

# Thyristor/Diode Modules M# 550

## Absolute Maximum Ratings

$V_{RRM}$ $V_{DRM}$ [V]							
	MCC	MCD	MDC	MCA	MCK	MCDA	MDCA
1200	550-12io1	550-12io1	550-12io1	550-12io1	550-12io1	550-12io1	550-12io1
1400	550-14io1	550-14io1	550-14io1	550-14io1	550-14io1	550-14io1	550-14io1
1600	550-16io1	550-16io1	550-16io1	550-16io1	550-16io1	550-16io1	550-16io1

	VOLTAGE RATINGS	MAXIMUM LIMITS	UNITS
$V_{DRM}$	Repetitive peak off-state voltage <sup>1)</sup>	1200-1600	V
$V_{DSM}$	Non-repetitive peak off-state voltage <sup>1)</sup>	1200-1600	V
$V_{RRM}$	Repetitive peak reverse voltage <sup>1)</sup>	1200-1600	V
$V_{RSM}$	Non-repetitive peak reverse voltage <sup>1)</sup>	1300-1700	V

	OTHER RATINGS	MAXIMUM LIMITS	UNITS
$I_{T(AV)M}$	Maximum average on-state current, $T_C = 85^\circ\text{C}$ <sup>2)</sup>	550	A
$I_{T(AV)M}$	Maximum average on-state current. $T_C = 100^\circ\text{C}$ <sup>2)</sup>	377	A
$I_{T(RMS)M}$	Nominal RMS on-state current, $T_C = 55^\circ\text{C}$ <sup>2)</sup>	1318	A
$I_{T(d.c.)}$	D.C. on-state current, $T_C = 55^\circ\text{C}$	1034	A
$I_{TSM}$	Peak non-repetitive surge $t_p = 10$ ms, $V_{RM} = 60\%V_{RRM}$ <sup>3)</sup>	18.0	kA
$I_{TSM2}$	Peak non-repetitive surge $t_p = 10$ ms, $V_{RM} \leq 10$ V <sup>3)</sup>	19.8	kA
$I^2t$	$I^2t$ capacity for fusing $t_p = 10$ ms, $V_{RM} = 60\%V_{RRM}$ <sup>3)</sup>	$1.62 \times 10^6$	$\text{A}^2\text{s}$
$I^2t$	$I^2t$ capacity for fusing $t_p = 10$ ms, $V_{RM} \leq 10$ V <sup>3)</sup>	$1.96 \times 10^6$	$\text{A}^2\text{s}$
$(di/dt)_{cr}$	Critical rate of rise of on-state current (repetitive) <sup>4)</sup>	150	$\text{A}/\mu\text{s}$
	Critical rate of rise of on-state current (non-repetitive) <sup>4)</sup>	300	$\text{A}/\mu\text{s}$
$V_{RGM}$	Peak reverse gate voltage	5	V
$P_{G(AV)}$	Mean forward gate power	4	W
$P_{GM}$	Peak forward gate power	30	W
$V_{ISOL}$	Isolation Voltage <sup>5)</sup>	3500	V
$T_{Vj\text{ op}}$	Operating temperature range	-40 to +125	$^\circ\text{C}$
$T_{stg}$	Storage temperature range	-40 to +150	$^\circ\text{C}$

### Notes:

- De-rating factor of 0.13% per  $^\circ\text{C}$  is applicable for  $T_{Vj}$  below  $25^\circ\text{C}$ .
- Single phase; 50 Hz,  $180^\circ$  half-sinewave.
- Half-sinewave,  $125^\circ\text{C}$   $T_{Vj}$  initial.
- $V_D = 67\% V_{DRM}$ ,  $I_{FG} = 2$  A,  $t_r \leq 0.5\mu\text{s}$ ,  $T_C = 125^\circ\text{C}$ .
- AC RMS voltage, 50 Hz, 1min test

**Thyristor Characteristics**

	PARAMETER	MIN.	TYP.	MAX.	TEST CONDITIONS <sup>1)</sup>	UNITS
V <sub>TM</sub>	Maximum peak on-state voltage	-	-	1.30	I <sub>TM</sub> = 1700 A	V
V <sub>TM</sub>	Maximum peak on-state voltage	-	-	1.26	I <sub>TM</sub> = 1500 A	V
V <sub>T0</sub>	Threshold voltage	-	-	0.839		V
r <sub>T</sub>	Slope resistance	-	-	0.244		mΩ
(dv/dt) <sub>cr</sub>	Critical rate of rise of off-state voltage	1000	-	-	V <sub>D</sub> = 80% V <sub>DRM</sub> , linear ramp, Gate o/c	V/μs
I <sub>DRM</sub>	Peak off-state current	-	-	70	Rated V <sub>DRM</sub>	mA
I <sub>RDM</sub>	Peak reverse current	-	-	70	Rated V <sub>RDM</sub>	mA
V <sub>GT</sub>	Gate trigger voltage	-	-	3.0	T <sub>vj</sub> = 25°C, V <sub>D</sub> = 10 V, I <sub>T</sub> = 3 A	V
I <sub>GT</sub>	Gate trigger current	-	-	300		mA
I <sub>H</sub>	Holding current	-	-	1000	T <sub>vj</sub> = 25°C	mA
t <sub>gd</sub>	Gate controlled turn-on delay time	-	0.6	1.5	I <sub>FG</sub> = 2 A, t <sub>r</sub> = 0.5 μs, V <sub>D</sub> = 67%V <sub>DRM</sub> , I <sub>TM</sub> = 2000 A, di/dt = 10 A/μs, T <sub>vj</sub> = 25°C	μs
t <sub>gt</sub>	Turn-on time	-	1.2	2.5		
Q <sub>rr</sub>	Recovered Charge	-	1700	-		μC
Q <sub>ra</sub>	Recovered Charge, 50% chord	-	1150	1300	I <sub>TM</sub> = 1000 A, t <sub>p</sub> = 1 ms, di/dt = 10A/μs, V <sub>R</sub> = 50 V	μC
I <sub>rm</sub>	Reverse recovery current	-	110	-		A
t <sub>rr</sub>	Reverse recovery time, 50% chord	-	20	-		μs
t <sub>q</sub>	Turn-off time	-	200	-	I <sub>TM</sub> = 1000 A, t <sub>p</sub> = 1 ms, di/dt = 10 A/μs, V <sub>R</sub> = 50 V, V <sub>DR</sub> = 80%V <sub>DRM</sub> , dv <sub>DR</sub> /dt = 20 V/μs	μs
		-	300	-	I <sub>TM</sub> = 1000 A, t <sub>p</sub> = 1 ms, di/dt = 10 A/μs, V <sub>R</sub> = 50 V, V <sub>DR</sub> = 80%V <sub>DRM</sub> , dv <sub>DR</sub> /dt = 200 V/μs	
R <sub>thJC</sub>	Thermal resistance, junction to case	-	-	0.062	Single Thyristor	K/W
		-	-	0.031	Whole Module	K/W
R <sub>thCH</sub>	Thermal resistance, case to heatsink	-	-	0.02	Single Thyristor	K/W
		-	-	0.01	Whole Module	K/W
F <sub>1</sub>	Mounting force (to heatsink)	4.25	-	5.75		Nm
F <sub>2</sub>	Mounting force (to terminals)	10.2	-	13.8	<sup>2)</sup>	Nm
W <sub>t</sub>	Weight	-	1.5	-		kg

**Diode Characteristics**

	PARAMETER	MIN.	TYP.	MAX.	TEST CONDITIONS <sup>1)</sup>	UNITS
V <sub>FM</sub>	Maximum peak forward voltage	-	-	0.98	I <sub>TM</sub> = 1800 A	V
V <sub>T0</sub>	Threshold voltage	-	-	0.72		V
r <sub>T</sub>	Slope resistance	-	-	0.143		mΩ
I <sub>RDM</sub>	Peak reverse current	-	-	50	Rated V <sub>RDM</sub>	mA
Q <sub>rr</sub>	Recovered Charge	-	2200	-		μC
Q <sub>ra</sub>	Recovered Charge, 50% chord	-	1800	2250	I <sub>TM</sub> = 1000 A, t <sub>p</sub> = 1ms, di/dt = 10 A/μs, V <sub>R</sub> = 50 V	μC
I <sub>RM</sub>	Reverse recovery current	-	145	-		A
t <sub>rr</sub>	Reverse recovery time, 50% chord	-	25	-		μs

**Notes:**1) Unless otherwise indicated T<sub>vj</sub>=125°C.

2) Screws must be lubricated

## Notes on Ratings and Characteristics

### 1.0 Voltage Grade Table

Voltage Grade	$V_{DRM}$ $V_{DSM}$ $V_{RRM}$ V	$V_{RSM}$ V	$V_D$ $V_R$ DC V
12	1200	1300	820
14	1400	1500	930
16	1600	1700	1040

### 2.0 Extension of Voltage Grades

This report is applicable to other voltage grades when supply has been agreed by Sales/Production.

### 3.0 De-rating Factor

A blocking voltage de-rating factor of 0.13%/°C is applicable to this device for  $T_{vj}$  below 25°C.

### 4.0 Repetitive dv/dt

Standard dv/dt is 1000V/μs.

### 5.0 Snubber Components

When selecting snubber components, care must be taken not to use excessively large values of snubber capacitor or excessively small values of snubber resistor. Such excessive component values may lead to device damage due to the large resultant values of snubber discharge current. If required, please consult the factory for assistance.

### 6.0 Rate of rise of on-state current

The maximum un-primed rate of rise of on-state current must not exceed 300A/μs at any time during turn-on on a non-repetitive basis. For repetitive performance, the on-state rate of rise of current must not exceed 150A/μs at any time during turn-on. Note that these values of rate of rise of current apply to the total device current including that from any local snubber network.

### 7.0 Gate Drive

The nominal requirement for a typical gate drive is illustrated below. An open circuit voltage of at least 30V is assumed. This gate drive must be applied when using the full di/dt capability of the device.

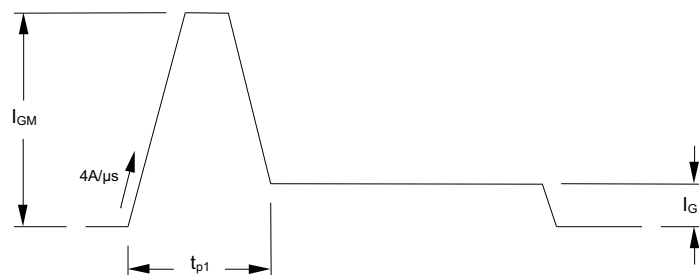

The magnitude of  $I_{GM}$  should be between five and ten times  $I_{GT}$ , which is shown on page 2. Its duration ( $t_{p1}$ ) should be 20μs or sufficient to allow the anode current to reach ten times  $I_L$ , whichever is greater. Otherwise, an increase in pulse current could be needed to supply the necessary charge to trigger. The 'back-porch' current  $I_G$  should remain flowing for the same duration as the anode current and have a magnitude in the order of 1.5 times  $I_{GT}$ .

## 8.0 Computer Modelling Parameters

### 8.1 Thyristor Dissipation Calculations

$$I_{AV} = \frac{-V_{T0} + \sqrt{V_{T0}^2 + 4 \cdot ff^2 \cdot r_T \cdot W_{AV}}}{2 \cdot ff^2 \cdot r_T} \quad \text{and:} \quad W_{AV} = \frac{\Delta T}{R_{th}}$$

$$\Delta T = T_{j \max} - T_K$$

Where  $V_{T0} = 0.839V$ ,  $r_T = 0.244m\Omega$  for the thyristor and  $V_{T0} = 0.72V$ ,  $r_T = 0.143m\Omega$  for the diode.

$R_{th}$  = Supplementary thermal impedance, see table below and

$ff$  = Form factor, see table below.

Supplementary Thermal Impedance							
Conduction Angle	30°	60°	90°	120°	180°	270°	d.c.
Square wave	0.07067	0.06791	0.06629	0.06525	0.06395	0.06277	0.062
Sine wave	0.06767	0.06536	0.06408	0.0633	0.062		

Form Factors							
Conduction Angle	30°	60°	90°	120°	180°	270°	d.c.
Square wave	3.464	2.449	2	1.732	1.414	1.149	1
Sine wave	3.98	2.778	2.22	1.879	1.57		

### 8.2 Calculating thyristor $V_T$ using ABCD Coefficients

The on-state characteristic  $I_T$  vs.  $V_T$ , on page 6 is represented in two ways;

- (i) the well established  $V_{T0}$  and  $r_T$  tangent used for rating purposes and
- (ii) a set of constants A, B, C, D, forming the coefficients of the representative equation for  $V_T$  in terms of  $I_T$  given below:

$$V_T = A + B \cdot \ln(I_T) + C \cdot I_T + D \cdot \sqrt{I_T}$$

The constants, derived by curve fitting software, are given below for both hot and cold characteristics. The resulting values for  $V_T$  agree with the true device characteristic over a current range, which is limited to that plotted.

25°C Coefficients		125°C Coefficients	
A	1.286736823	A	-0.280091677
B	-0.06151157	B	0.3017156
C	$9.70079 \times 10^{-5}$	C	$6.10016 \times 10^{-4}$
D	0.0139607	D	-0.03762241

8.3 D.C. Thermal Impedance Calculation

$$r_t = \sum_{p=1}^{p=n} r_p \cdot \left( 1 - e^{-\frac{t}{\tau_p}} \right)$$

Where  $p = 1$  to  $n$

- $n$  = number of terms in the series and
- $t$  = Duration of heating pulse in seconds.
- $r_t$  = Thermal resistance at time  $t$ .
- $r_p$  = Amplitude of  $p$ th term.
- $\tau_p$  = Time Constant of  $r$ th term).

The coefficients for this device are shown in the tables below:

D.C.				
Term	1	2	3	4
$r_p$	0.05428	$4.4894 \times 10^{-3}$	$2.3382 \times 10^{-3}$	$8.759 \times 10^{-4}$
$\tau_p$	2.69428	0.126017	0.013878	$1.435 \times 10^{-3}$

9.0 Reverse recovery ratings

(i)  $Q_{ra}$  is based on 50%  $I_{RM}$  chord as shown in Fig. 1

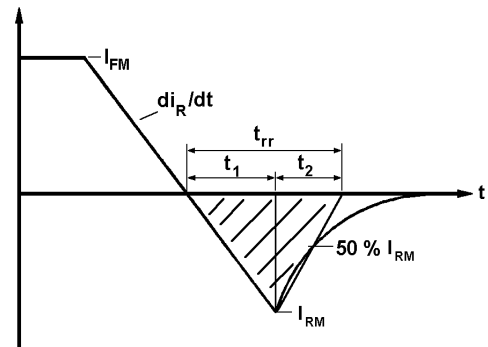

Fig. 1

(ii)  $Q_{rr}$  is based on a 150  $\mu s$  integration time i.e.

$$Q_{rr} = \int_0^{150 \mu s} i_{rr} \cdot dt$$

(iii)

$$K \text{ Factor} = \frac{t_1}{t_2}$$

**Thyristor Curves**

Figure 1 – On-state characteristics of Limit device

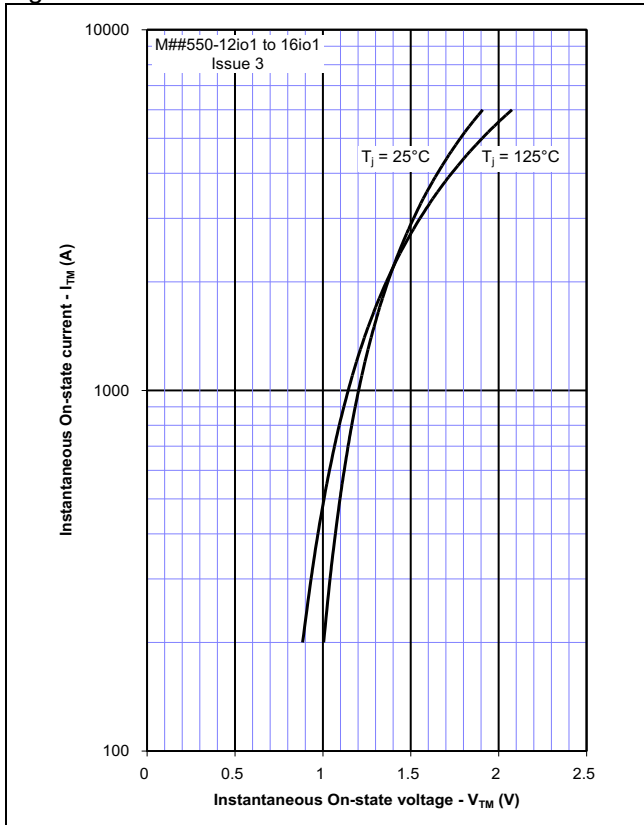

Figure 2 – Transient thermal impedance

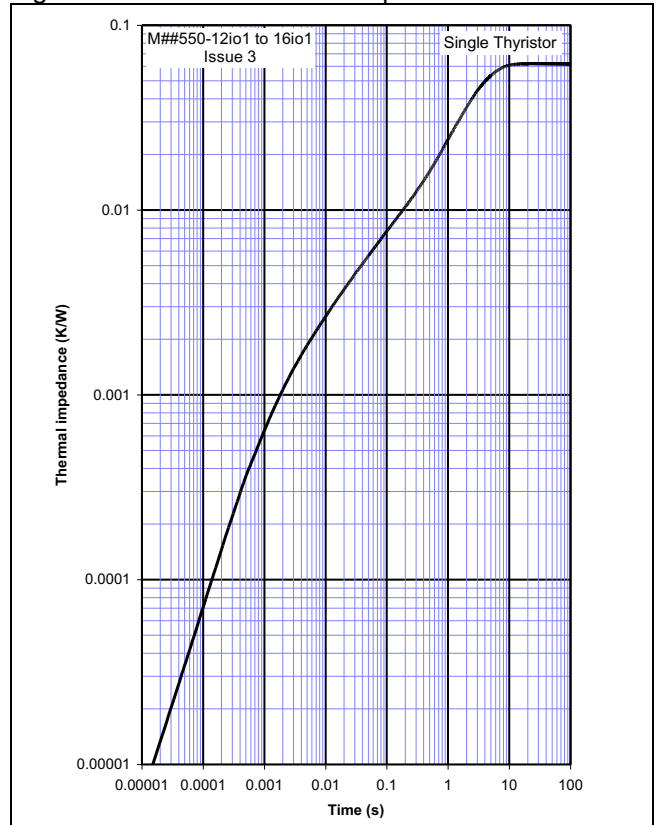

Figure 3 – Gate characteristics – Trigger limits

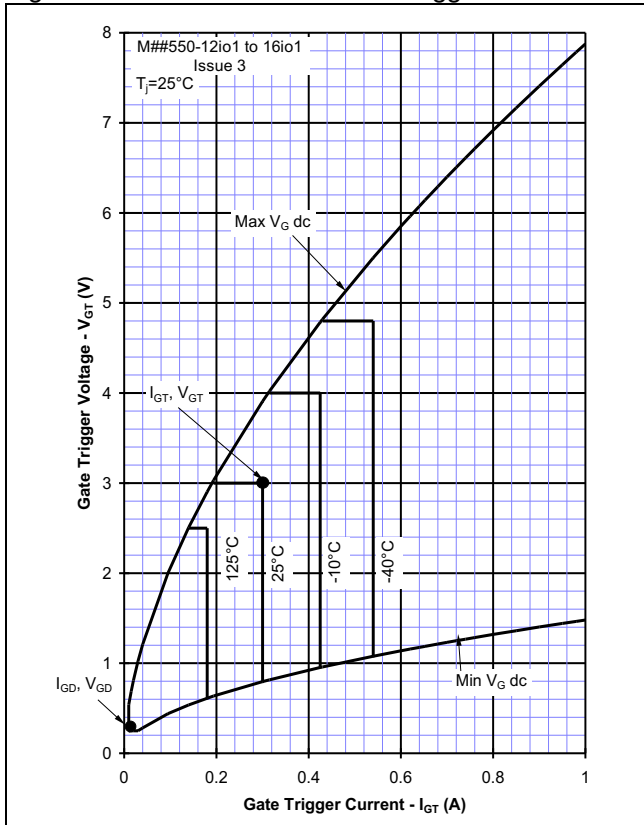

Figure 4 – Gate characteristics – Power curves

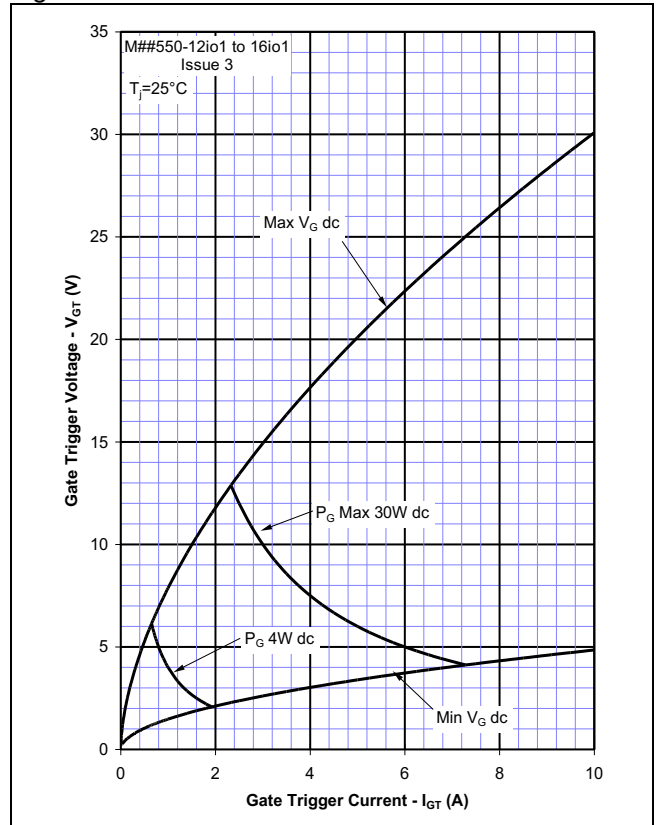

Figure 5 – Total recovered charge,  $Q_{rr}$

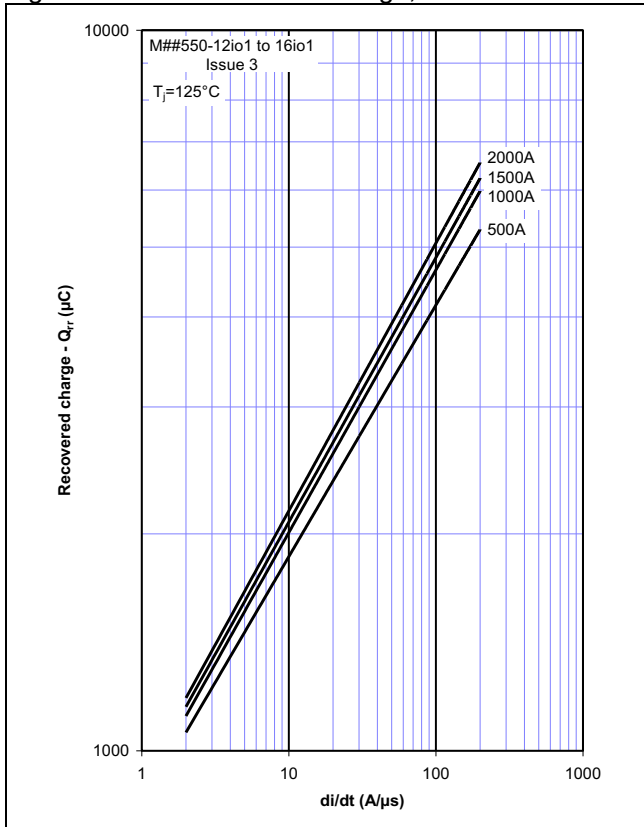

Figure 6 – Recovered charge,  $Q_{ra}$  (50% chord)

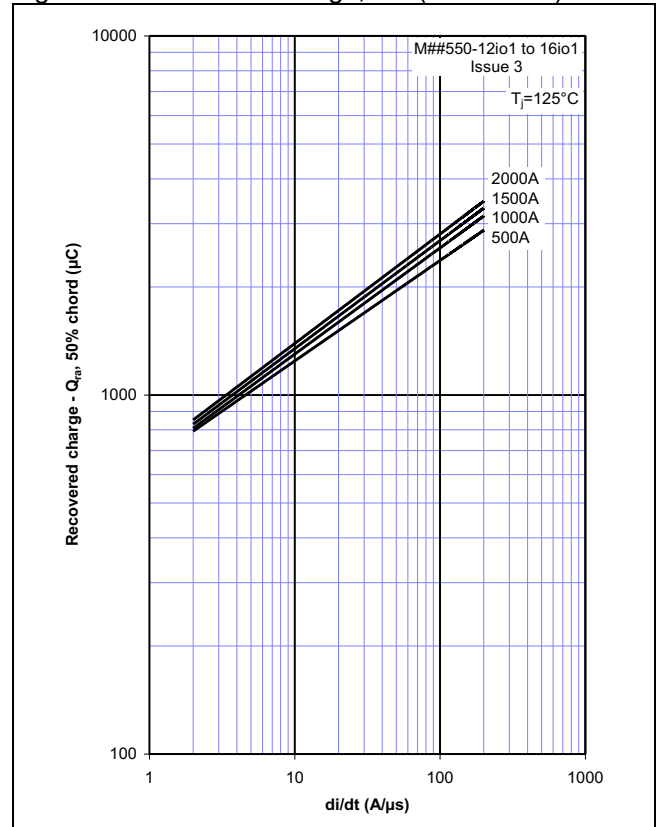

Figure 7 – Peak reverse recovery current,  $I_{rm}$

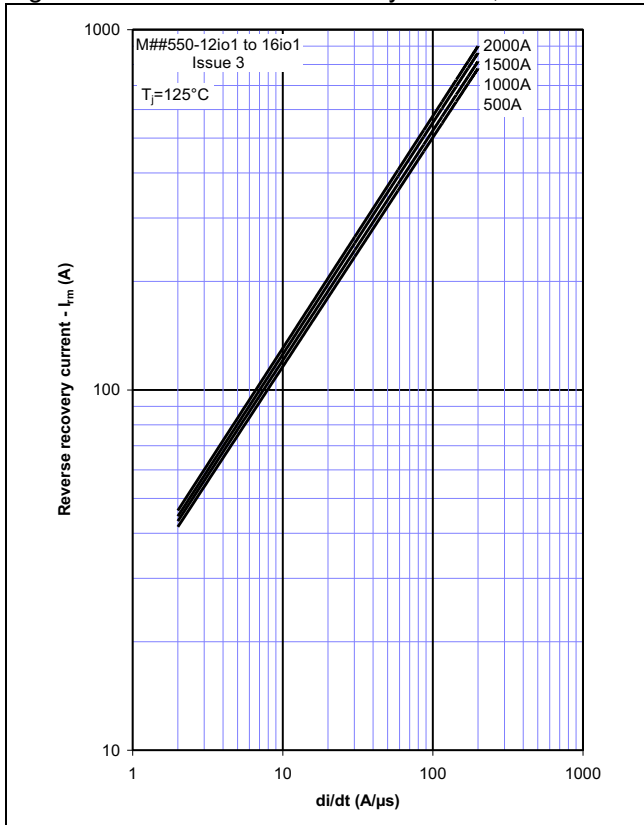

Figure 8 – Maximum recovery time,  $t_{rr}$  (50% chord)

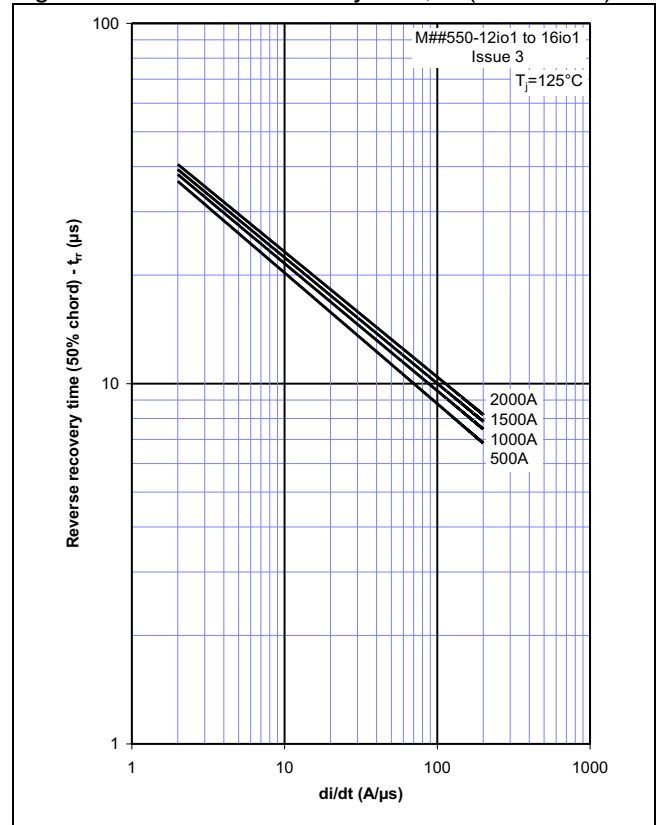

Figure 9 – On-state current vs. Power dissipation – Sine wave

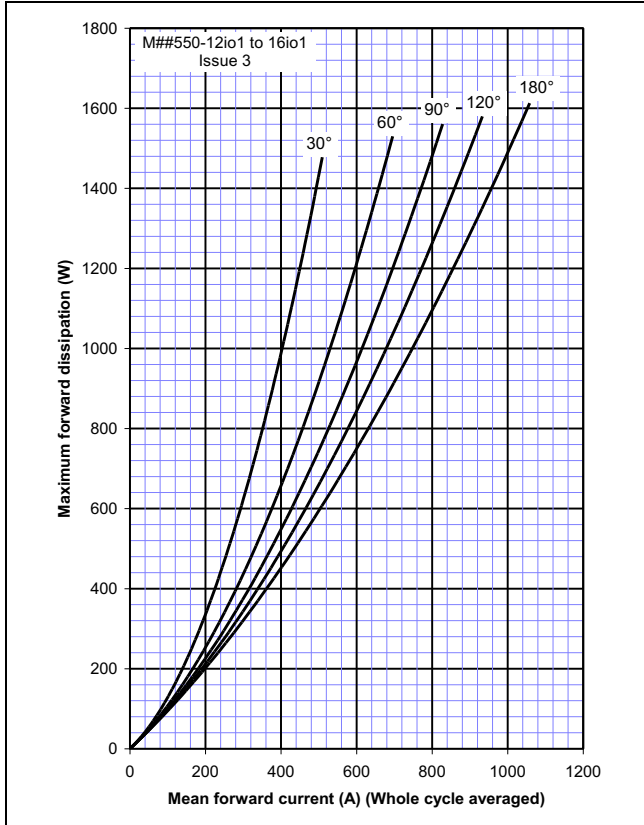

Figure 10 – On-state current vs. Heatsink temperature – Sine wave

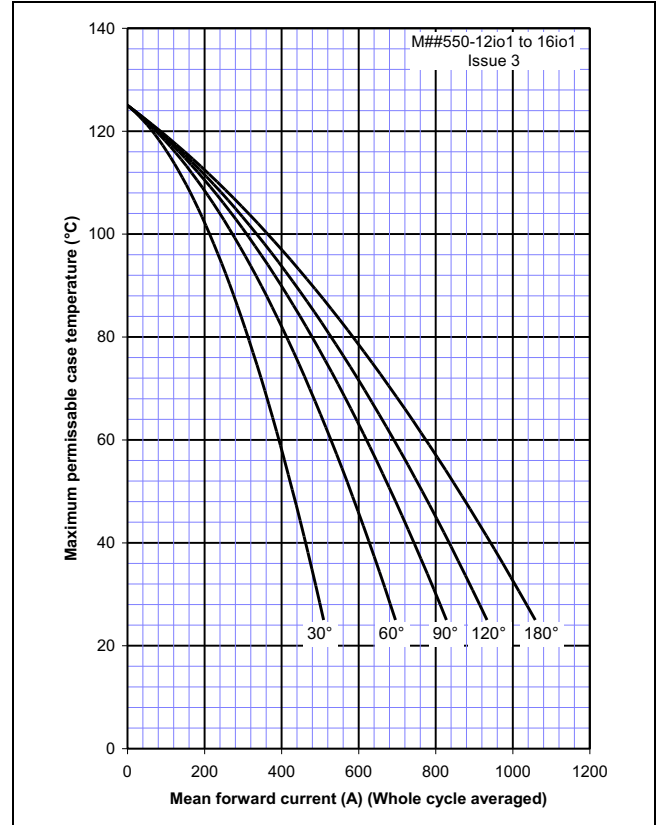

Figure 11 – On-state current vs. Power dissipation – Square wave

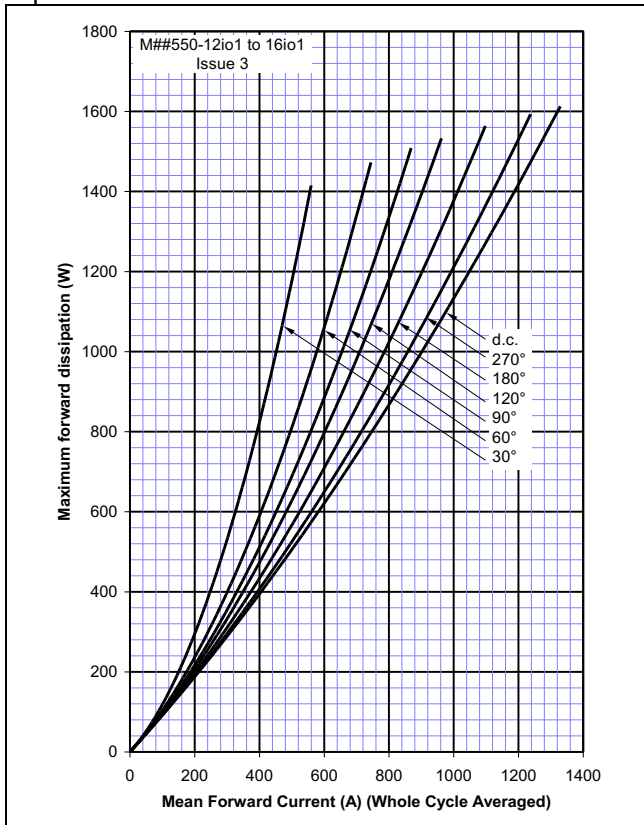

Figure 12 – On-state current vs. Heatsink temperature – Square wave

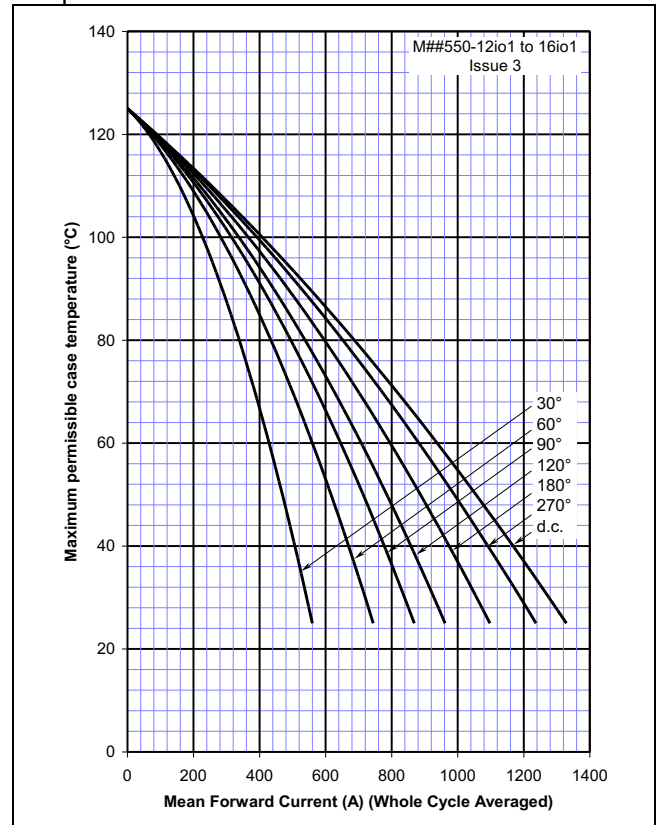
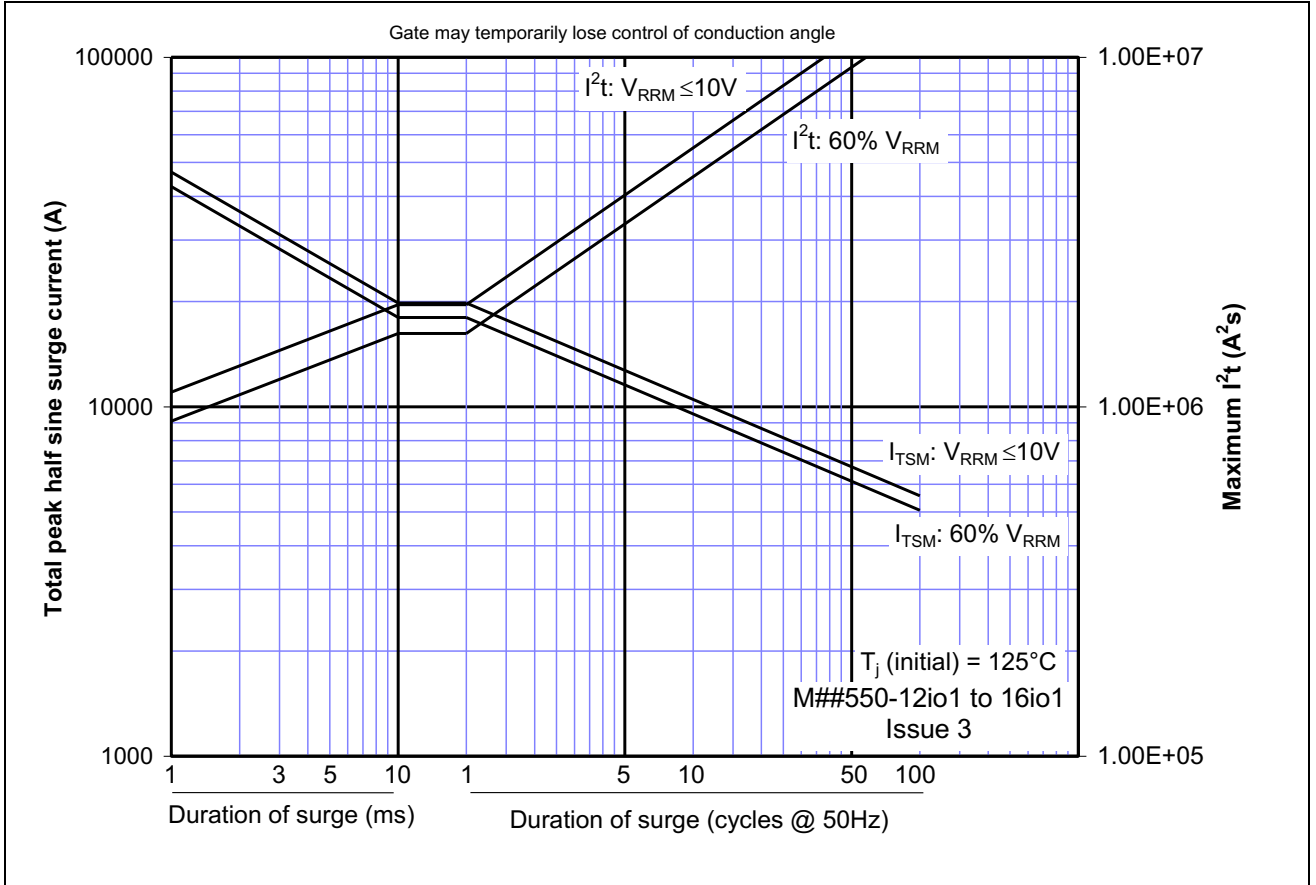



Figure 13 – Maximum surge and  $I^2t$  Ratings



**Diode curves**

Figure 14 – Instantaneous forward voltage  $V_F$

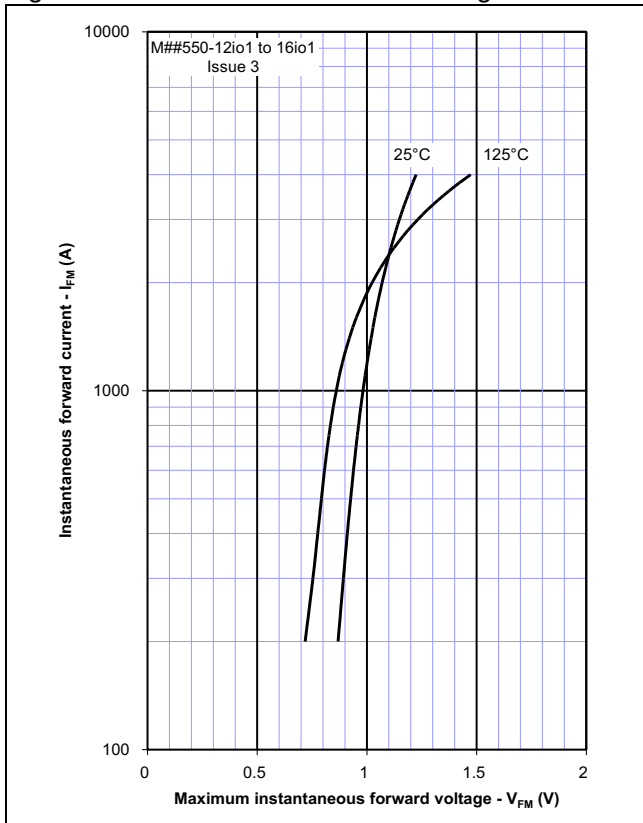

Figure 15 – Transient thermal impedance

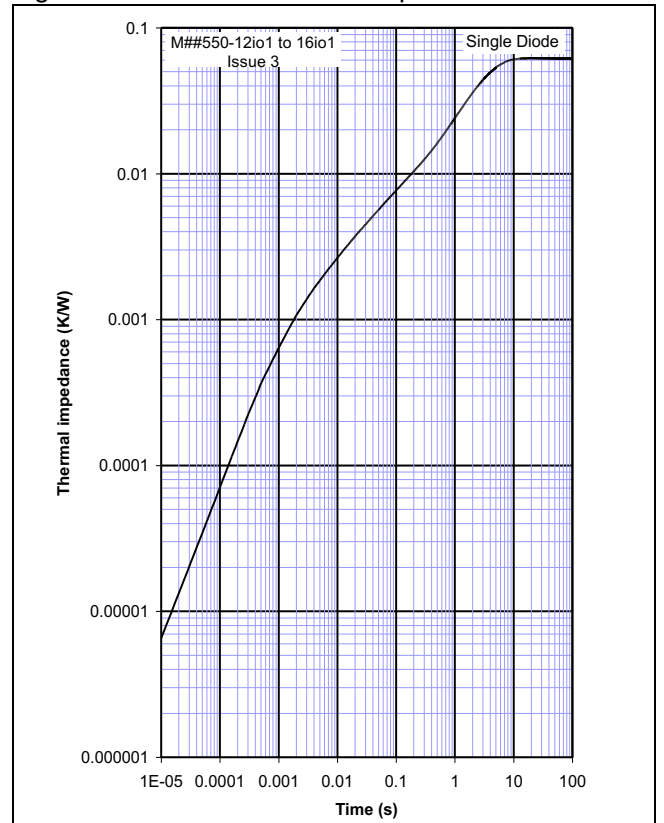

Figure 16 – Total recovered charge,  $Q_{rr}$

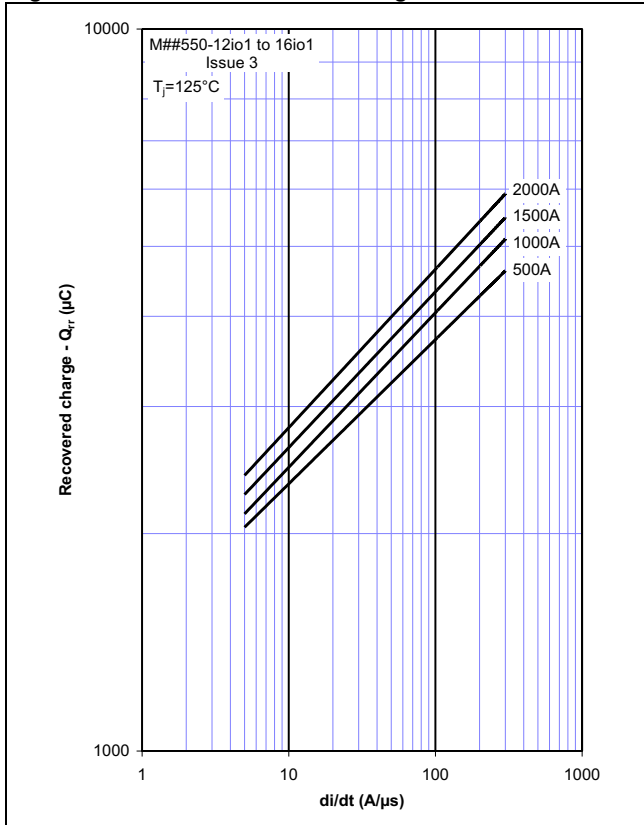

Figure 17 – Recovered charge,  $Q_{ra}$  (50% chord)

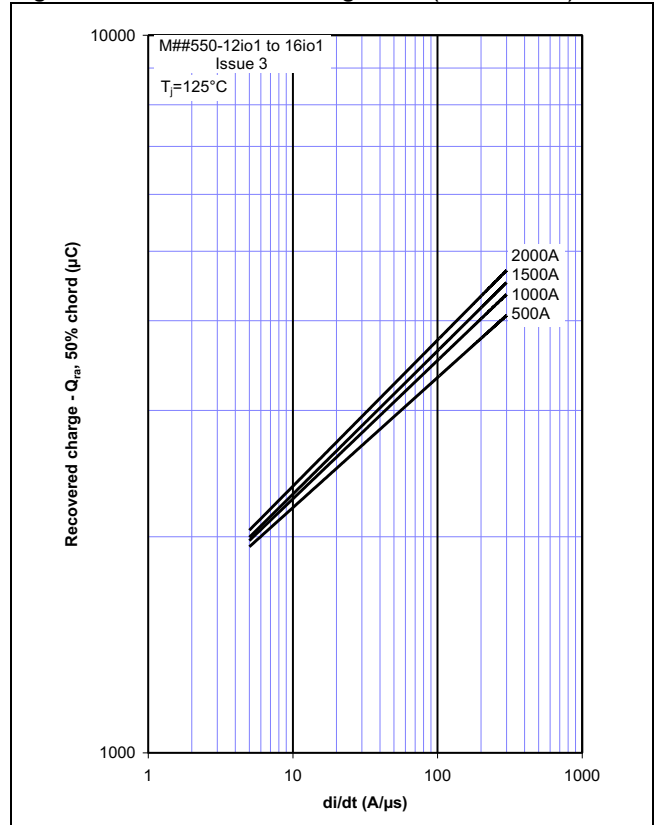

Figure 18 – Peak reverse recovery current,  $I_{rm}$

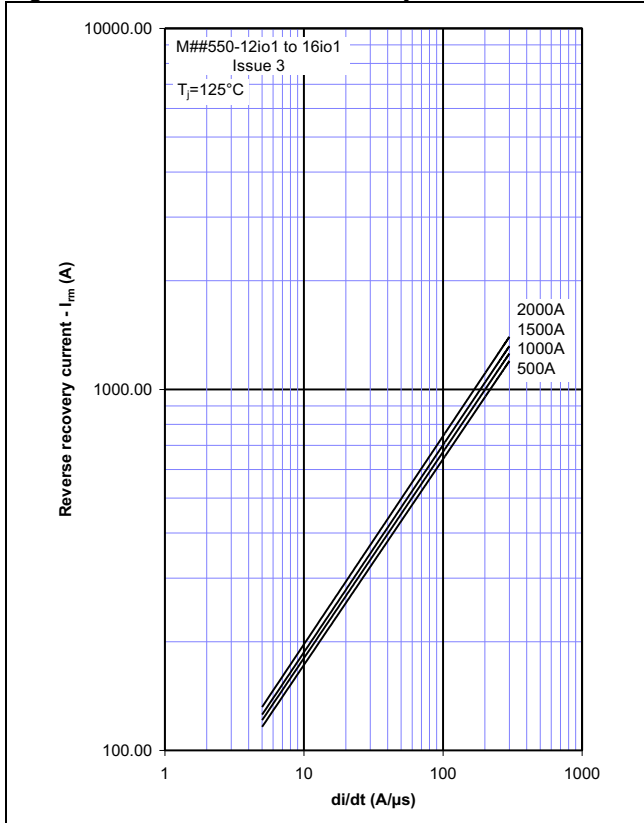
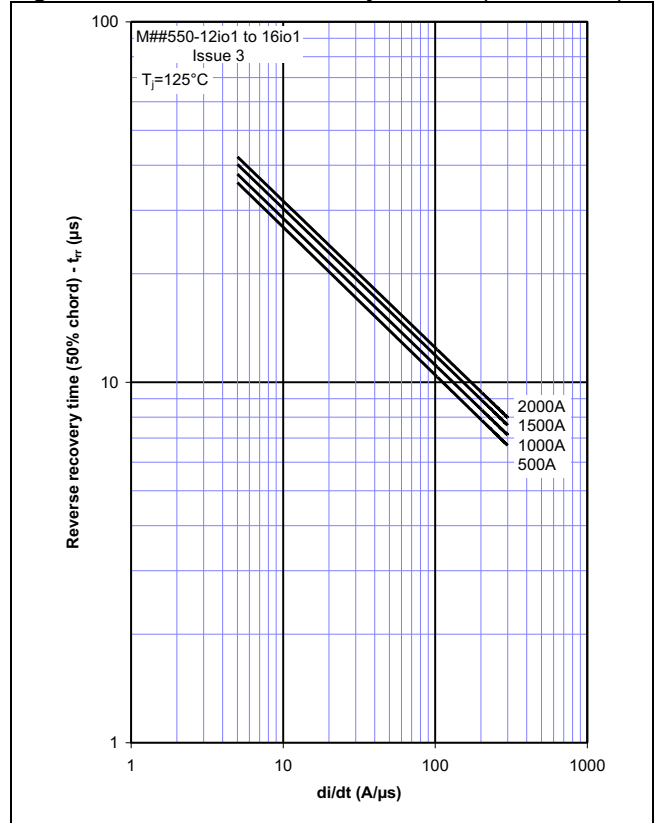
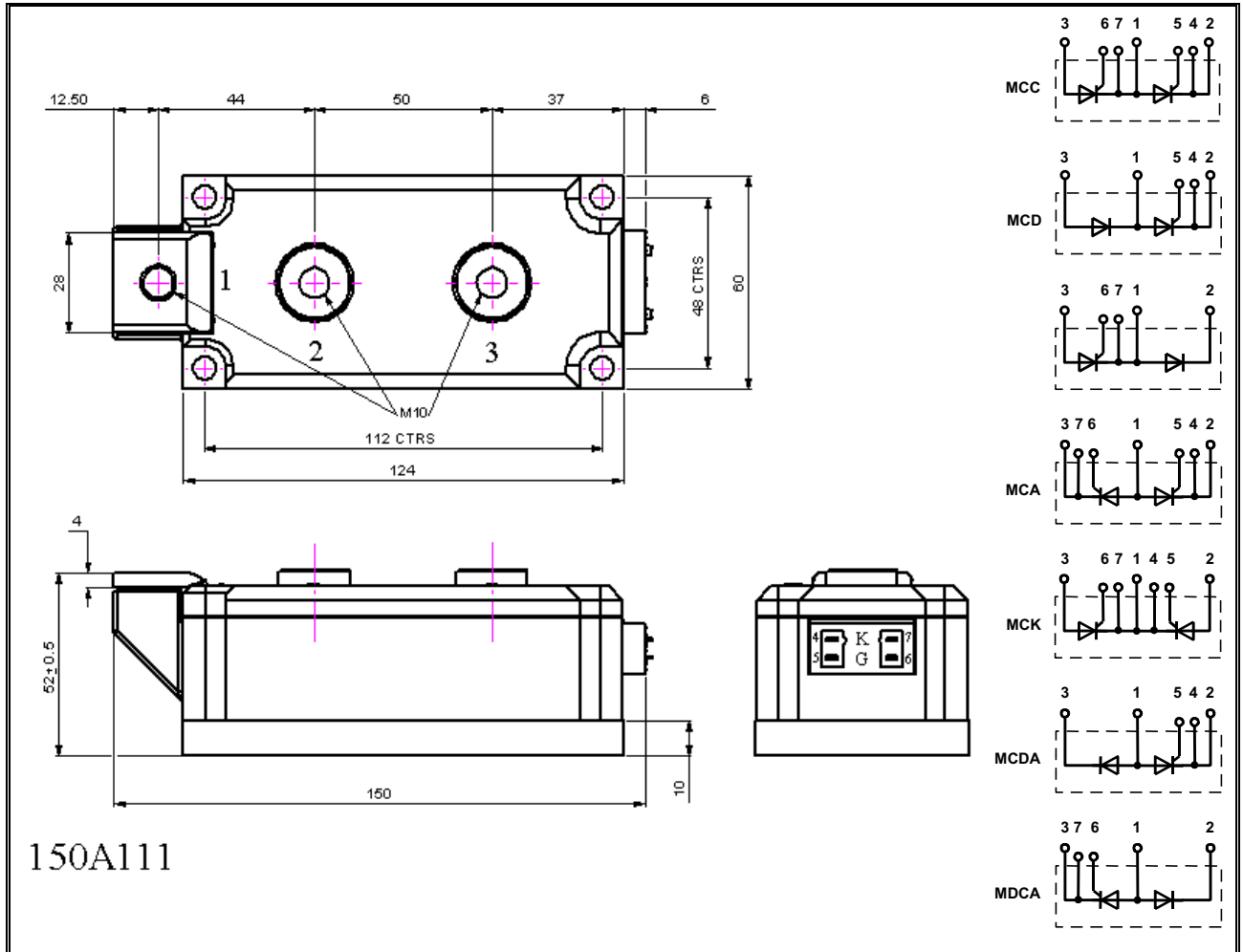

Figure 19 – Maximum recovery time,  $t_{rr}$  (50% chord)



**Outline Drawing & Ordering Information**



150A111

**ORDERING INFORMATION**

(Please quote 11 digit code as below)

M	##	550	◆◆	io	1
Fixed Type Code	Configuration code CC, CD, DC, CA, CK, CDA, DCA	Average Current Rating	Voltage code $V_{RRM}/100$ 12-16	i = Critical dv/dt 1000 V/ $\mu$ s o = Typical turn-off time	Fixed Version Code

Order code: MCC550-14io1- MCC configuration, 1400V  $V_{RRM}$

**IXYS Semiconductor GmbH**  
Edisonstraße 15  
D-68623 Lampertheim  
Tel: +49 6206 503-0  
Fax: +49 6206 503-627  
E-mail: [marcom@ixys.de](mailto:marcom@ixys.de)



[www.ixys.com](http://www.ixys.com)

**IXYS Corporation**  
1590 Buckeye Drive  
Milpitas CA 95035-7418 USA  
Tel: +1 (408) 457 9000  
Fax: +1 (408) 496 0670  
E-mail: [sales@ixys.net](mailto:sales@ixys.net)

**WESTCODE**

An IXYS Company

[www.westcode.com](http://www.westcode.com)

**Westcode Semiconductors Ltd**  
Langley Park Way, Langley Park,  
Chippenham, Wiltshire, SN15 1GE.  
Tel: +44 (0)1249 444524  
Fax: +44 (0)1249 659448  
E-mail: [WSL.sales@westcode.com](mailto:WSL.sales@westcode.com)

**IXYS Long Beach**  
3270 Cherry Avenue  
Long Beach CA 90807 USA  
Tel: +1 (562) 595 6971  
Fax: +1 (562) 595 8182  
E-mail: [WSI.sales@westcode.com](mailto:WSI.sales@westcode.com)

The information contained herein is confidential and is protected by Copyright. The information may not be used or disclosed except with the written permission of and in the manner permitted by the proprietors IXYS Semiconductors GmbH.  
In the interest of product improvement, IXYS reserves the right to change specifications at any time without prior notice.

© IXYS Semiconductor GmbH.



---

Disclaimer Notice - Information furnished is believed to be accurate and reliable. However, users should independently evaluate the suitability of and test each product selected for their own applications. Littelfuse products are not designed for, and may not be used in, all applications. Read complete Disclaimer Notice at [www.littelfuse.com/disclaimer-electronics](http://www.littelfuse.com/disclaimer-electronics).