

Three Phase Half Controlled Rectifier Bridge, B6HK

$$I_{dAVM} = 110/167 \text{ A}$$

$$V_{RRM} = 1200-1600 \text{ V}$$

V_{RSM} V_{DSM} V	V_{RRM} V_{DRM} V	Type
1300 1700	1200 1600	VVZ 110-12io7 VVZ 175-12io7 VVZ 175-16io7

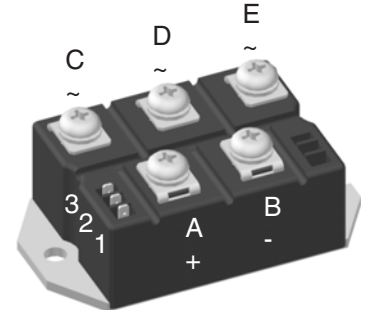
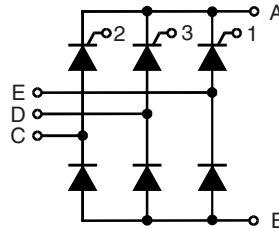

Symbol	Test Conditions	Maximum Ratings		
		VVZ 110	VVZ 175	
I_{dAV} I_{FRMS}, I_{TRMS}	$T_C = 85^\circ\text{C}$; module per leg	110 58	167 89	A A
I_{FSM}, I_{TSM}	$T_{VJ} = 45^\circ\text{C}$; $V_R = 0$ $t = 10 \text{ ms (50 Hz), sine}$ $t = 8.3 \text{ ms (60 Hz), sine}$	1150 1230	1500 1600	A A
	$T_{VJ} = T_{VJM}$; $V_R = 0$ $t = 10 \text{ ms (50 Hz), sine}$ $t = 8.3 \text{ ms (60 Hz), sine}$	1000 1070	1350 1450	A A
I^2t	$T_{VJ} = 45^\circ\text{C}$; $V_R = 0$ $t = 10 \text{ ms (50 Hz), sine}$ $t = 8.3 \text{ ms (60 Hz), sine}$	6600 6280	11200 10750	A^2s A^2s
	$T_{VJ} = T_{VJM}$; $V_R = 0$ $t = 10 \text{ ms (50 Hz), sine}$ $t = 8.3 \text{ ms (60 Hz), sine}$	5000 4750	9100 8830	A^2s A^2s
$(di/dt)_{cr}$	$T_{VJ} = T_{VJM}$ repetitive, $I_T = 50 \text{ A}$ $f = 400 \text{ Hz}$, $t_p = 200 \mu\text{s}$ $V_D = 2/3 V_{DRM}$ $I_G = 0.3 \text{ A}$, non repetitive, $di_G/dt = 0.3 \text{ A}/\mu\text{s}$, $I_T = 1/3 \cdot I_{dAV}$	150 500		$\text{A}/\mu\text{s}$ $\text{A}/\mu\text{s}$
$(dv/dt)_{cr}$	$T_{VJ} = T_{VJM}$; $V_{DR} = 2/3 V_{DRM}$ $R_{GK} = \infty$; method 1 (linear voltage rise)	1000		$\text{V}/\mu\text{s}$
V_{RGM}		10		V
P_{GM}	$T_{VJ} = T_{VJM}$ $t_p = 30 \mu\text{s}$ $I_T = I_{TAVM}$ $t_p = 500 \mu\text{s}$ $t_p = 10 \text{ ms}$	≤ 10 ≤ 5 ≤ 1		W W W
P_{GAVM}		0.5		W
T_{VJ}		-40...+125		$^\circ\text{C}$
T_{VJM}		125		$^\circ\text{C}$
T_{stg}		-40...+125		$^\circ\text{C}$
V_{ISOL}	50/60 Hz, RMS $t = 1 \text{ min}$ $I_{ISOL} \leq 1 \text{ mA}$ $t = 1 \text{ s}$	2500 3000		V~ V~
M_d	Mounting torque (M6) Terminal connection torque (M6)	$5 \pm 15 \%$ $5 \pm 15 \%$		Nm Nm
Weight	typ.	300		g

Data according to IEC 60747 and refer to a single thyristor/diode unless otherwise stated.

IXYS reserves the right to change limits, test conditions and dimensions.

20100706b

Features

- Package with screw terminals
- Isolation voltage 3000 V~
- Planar passivated chips
- UL registered E72873

Applications

- Input rectifier for PWM converter
- Input rectifier for switch mode power supplies (SMPS)
- Softstart capacitor charging

Advantages

- Easy to mount with two screws
- Space and weight savings
- Improved temperature and power cycling

Symbol	Test Conditions	Characteristic Values		
		VVZ 110	VVZ 175	
I_R, I_D	$V_R = V_{RRM}; V_D = V_{DRM}$	$T_{VJ} = T_{VJM}$	≤ 5	mA
		$T_{VJ} = 25^\circ\text{C}$	≤ 0.3	mA
V_F, V_T	$I_F, I_T = 200 \text{ A}, T_{VJ} = 25^\circ\text{C}$	≤ 1.75	1.57	V
V_{T0}	For power-loss calculations only	0.85	0.85	V
r_T	($T_{VJ} = 125^\circ\text{C}$)	6	3.5	m Ω
V_{GT}	$V_D = 6 \text{ V};$	$T_{VJ} = 25^\circ\text{C}$	≤ 1.5	V
		$T_{VJ} = -40^\circ\text{C}$	≤ 1.6	V
I_{GT}	$V_D = 6 \text{ V};$	$T_{VJ} = 25^\circ\text{C}$	≤ 100	mA
		$T_{VJ} = -40^\circ\text{C}$	≤ 200	mA
V_{GD}	$T_{VJ} = T_{VJM}; V_D = \frac{2}{3} V_{DRM}$	≤ 0.2	0.2	V
I_{GD}	$T_{VJ} = T_{VJM}; V_D = \frac{2}{3} V_{DRM}$	≤ 5	5	mA
I_L	$I_G = 0.3 \text{ A}; t_G = 30 \mu\text{s}; di_G/dt = 0.3 \text{ A}/\mu\text{s}; T_{VJ} = 25^\circ\text{C}$	≤ 450	450	mA
I_H	$T_{VJ} = 25^\circ\text{C}; V_D = 6 \text{ V}; R_{GK} = \infty$	≤ 200	200	mA
t_{gd}	$T_{VJ} = 25^\circ\text{C}; V_D = \frac{1}{2} V_{DRM}; I_G = 0.3 \text{ A}; di_G/dt = 0.3 \text{ A}/\mu\text{s}$	≤ 2	2	μs
R_{thJC}	per thyristor (diode); DC current per module	0.65	0.46	K/W
		0.108	0.077	K/W
R_{thJH}	per thyristor (diode); DC current per module	0.8	0.55	K/W
		0.133	0.092	K/W
d_s	Creeping distance on surface	10	10	mm
d_A	Creepage distance in air	9.4	9.4	mm
a	Max. allowable acceleration	50	50	m/s ²

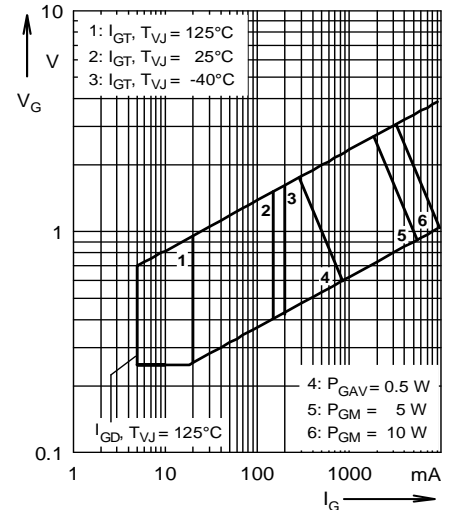

Fig. 1 Gate trigger characteristics

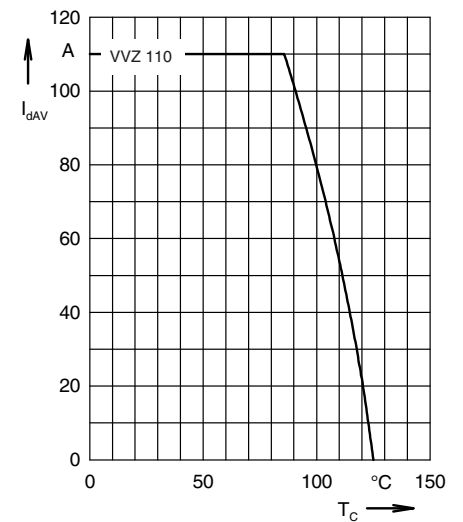

Fig. 2 DC output current at case temperature

Dimensions in mm (1 mm = 0.0394")

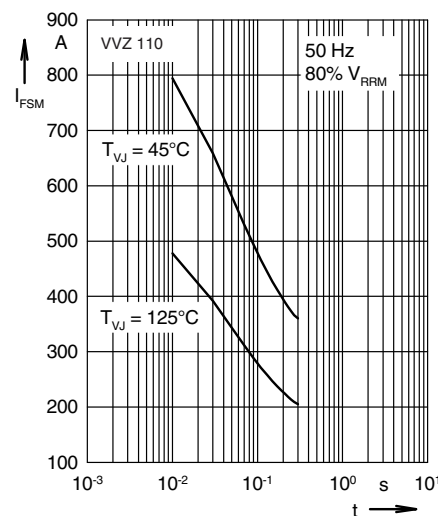
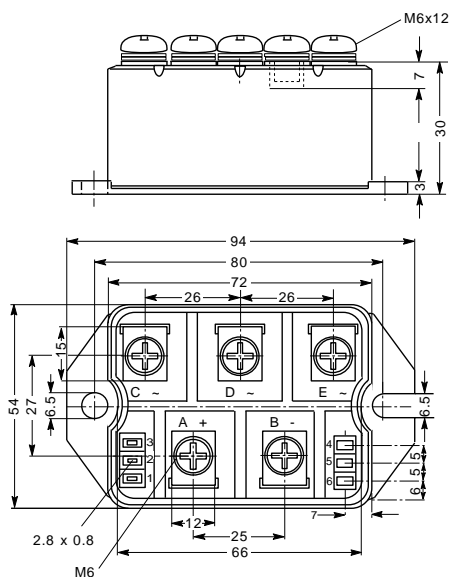

Fig. 3 Surge overload current
 I_{FSM} : Crest value, t: duration

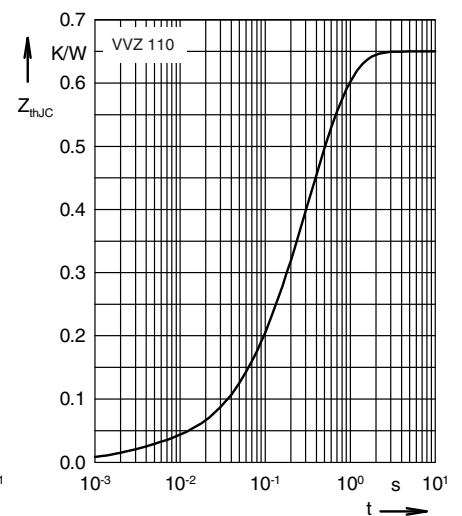

Fig. 4 Transient thermal impedance junction to case (per leg)



Disclaimer Notice - Information furnished is believed to be accurate and reliable. However, users should independently evaluate the suitability of and test each product selected for their own applications. Littelfuse products are not designed for, and may not be used in, all applications. Read complete Disclaimer Notice at www.littelfuse.com/disclaimer-electronics.