

SKNa 86, SKRa 86



Stud Diode

V_{RSM} V	$V_{(BR)min}$ V	$I_{FRMS} = 185$ A (maximum value for continuous operation) $I_{FAV} = 85$ A (sin. 180; $T_c = 130$ °C)	
1400	1400	SKNa 86/14	SKRa 86/14
1800	1800	SKNa 86/18	SKRa 86/18
2000	2000	SKNa 86/20	SKRa 86/20

Avalanche Diodes

SKNa 86
SKRa 86

Features

- Avalanche type reverse characteristic of 2000 V
- Hermetic metal cases with glass insulator
- Threaded studs ISO M8 or 1/4"-28 UNF-2A²⁾
- **SKN**: anode to stud
- **SKR**: cathode to stud

Typical Applications

- DC supply for magnets or solenoids (brakes, valves, etc.)
- Field coil supply for DC motors
- Series connections for high voltage applications like dust precipitators

1) Mounting with grease-like thermal compound or joint contact compound

2) M8x1,25 is standard; "UNF" should be added in description for 1/4"-28 UNF 2A.

Symbol	Condition	Values	Units
I_{FAV}	sin. 180 ; $T_c = 100$ °C	115	A
I_{FSM}	$T_{vj} = 25^\circ$ C ; 10 ms $T_{vj} = 180^\circ$ C ; 10 ms	1500 1275	A A
i^2t	$T_{vj} = 25^\circ$ C ; 8,3...10 ms $T_{vj} = 180^\circ$ C ; 8,3...10 ms	11250 8125	A ² s A ² s
V_F	$T_{vj} = 25^\circ$ C, $I_F = 150$ A	max. 1,3	V
$V_{(TO)}$	$T_{vj} = 180^\circ$ C	0,85	V
r_T	$T_{vj} = 180^\circ$ C	3	mΩ
I_R	$T_{vj} = 180^\circ$ C ; $V_R = V_{(BR)min}$	10	mA
P_{RSM}	$T_{vj} = 180^\circ$ C, $t_P = 10$ μs	20	kW
$R_{th(j-c)}$		0,4	KW
$R_{th(c-s)}$		0,2	KW
T_{vj}		-40...+180	°C
T_{stg}		-40...+180	°C
V_{isol}		-	V~
M_s	M8 Stud	4	Nm
	1/4"-28 UNF 2A	2,5	Nm
	M8 Stud (lubricated) ¹⁾	3	Nm
	1/4"-28 UNF 2A (lubricated) ¹⁾	2	Nm
a		5 * 9,81	m/s ²
m	approx.	20	g
Case		E 10	

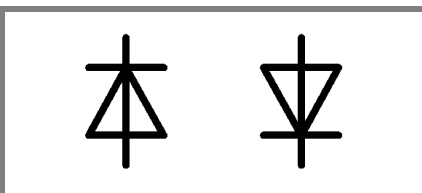

SKN

SKR

SKNa 86, SKRa 86

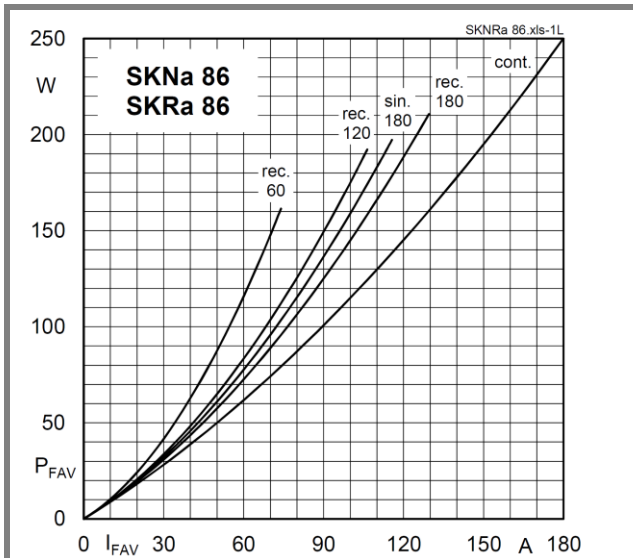

Fig. 1L Power dissipation vs. forward current

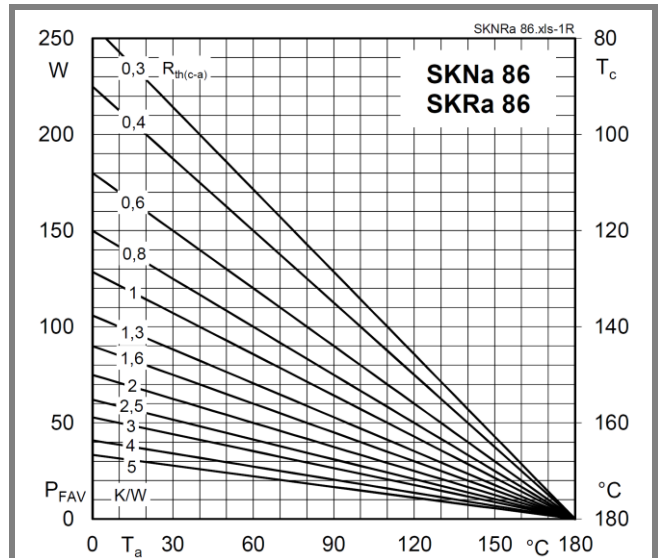

Fig. 1R Power dissipation vs. ambient temperature

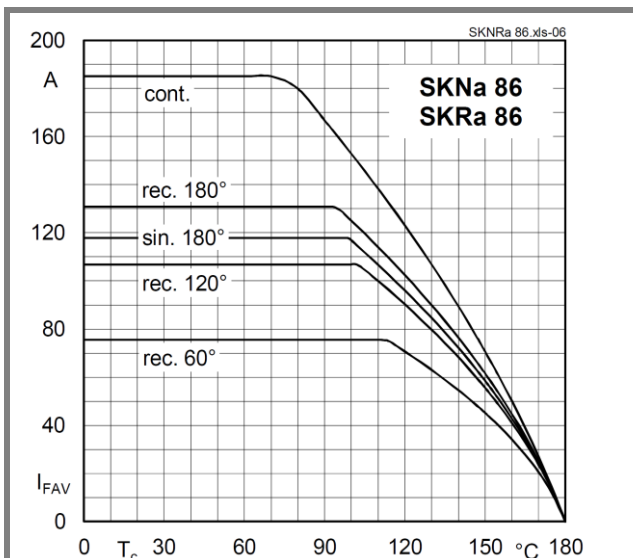

Fig. 2 Forward current vs. case temperature

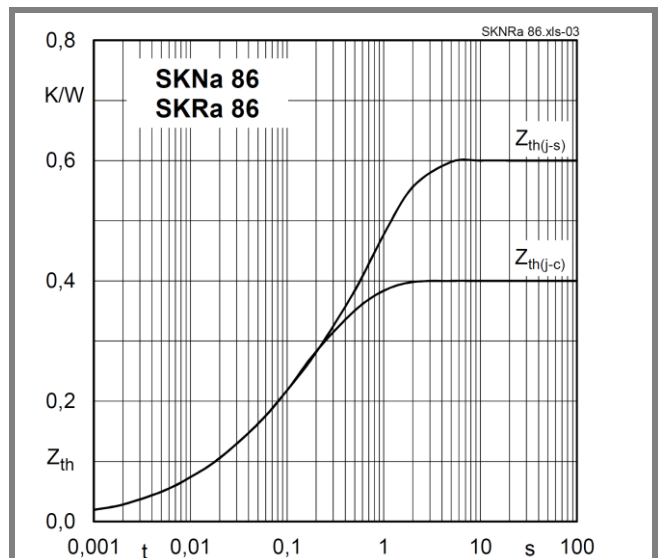

Fig. 4 Transient thermal impedance vs. time

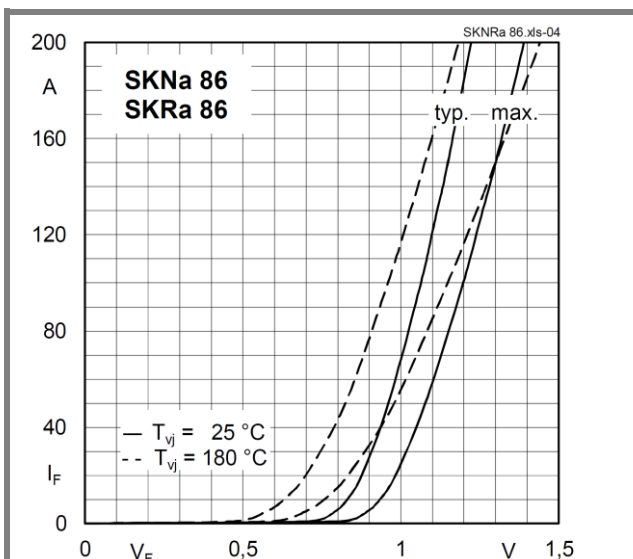

Fig. 5 Forward characteristics

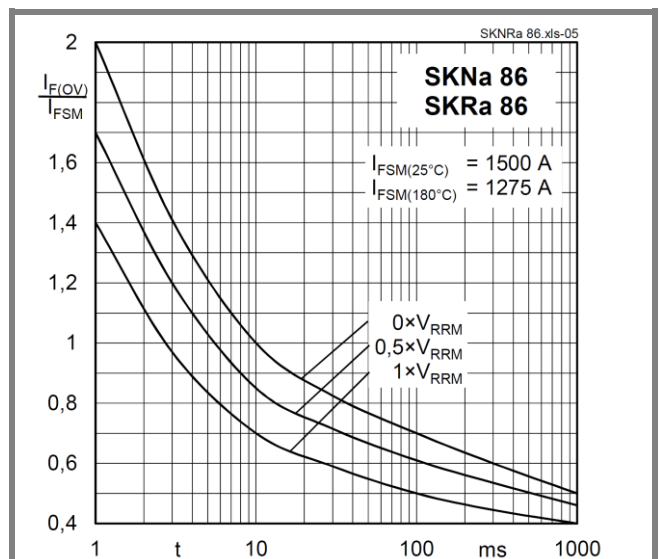
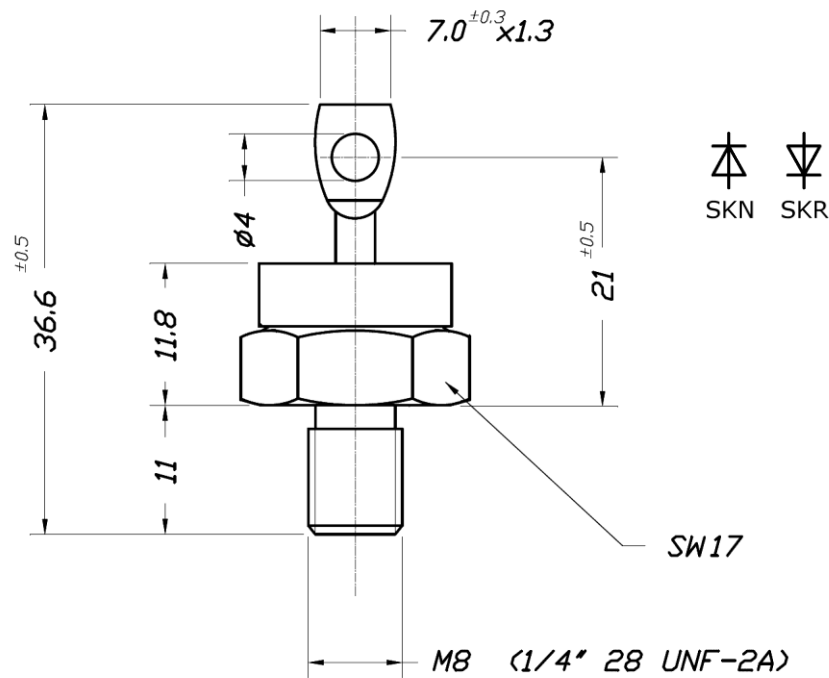

Fig. 6 Surge overload current vs. time



Case E10 (JEDEC: DO-203 AB (DO-5))

*IMPORTANT INFORMATION AND WARNINGS

The specifications of SEMIKRON products may not be considered as guarantee or assurance of product characteristics ("Beschaffenhheitsgarantie"). The specifications of SEMIKRON products describe only the usual characteristics of products to be expected in typical applications, which may still vary depending on the specific application. Therefore, products must be tested for the respective application in advance. Application adjustments may be necessary. The user of SEMIKRON products is responsible for the safety of their applications embedding SEMIKRON products and must take adequate safety measures to prevent the applications from causing a physical injury, fire or other problem if any of SEMIKRON products become faulty. The user is responsible to make sure that the application design is compliant with all applicable laws, regulations, norms and standards. Except as otherwise explicitly approved by SEMIKRON in a written document signed by authorized representatives of SEMIKRON, SEMIKRON products may not be used in any applications where a failure of the product or any consequences of the use thereof can reasonably be expected to result in personal injury. No representation or warranty is given and no liability is assumed with respect to the accuracy, completeness and/or use of any information herein, including without limitation, warranties of non-infringement of intellectual property rights of any third party. SEMIKRON does not assume any liability arising out of the applications or use of any product; neither does it convey any license under its patent rights, copyrights, trade secrets or other intellectual property rights, nor the rights of others. SEMIKRON makes no representation or warranty of non-infringement or alleged noninfringement of intellectual property rights of any third party which may arise from applications. Due to technical requirements our products may contain dangerous substances. For information on the types in question please contact the nearest SEMIKRON sales office. This document supersedes and replaces all information previously supplied and may be superseded by updates. SEMIKRON reserves the right to make changes.